

LINE CODING



Data encoding

- Data encoding is method to convert the data into signal form.
- The signal may be of digital or in analog form.
- An analog signal is transmitted over a long distance . But if we use, digital transmission , then we required a repeater between every 40 to 50 km.

transmission

A computer network is designed to send information from one point in the network to another.

While designing a network, we have two choices

- Convert data into digital signal
- Convert data into analog signal

Digital transmission includes

- Line coding (binary data to digital signals)
- Improve the efficiency of line coding
- Sampling (a technique for changing analog data to binary data)

Data Encoding

```
graph TD; A[Data Encoding] --> B[Digital to Digital]; A --> C[Digital to Analog]; A --> D[Analog to Analog]; A --> E[Analog to Digital];
```

Digital
to
Digital

Digital
to
Analog

Analog
to
Analog

Analog
to
Digital

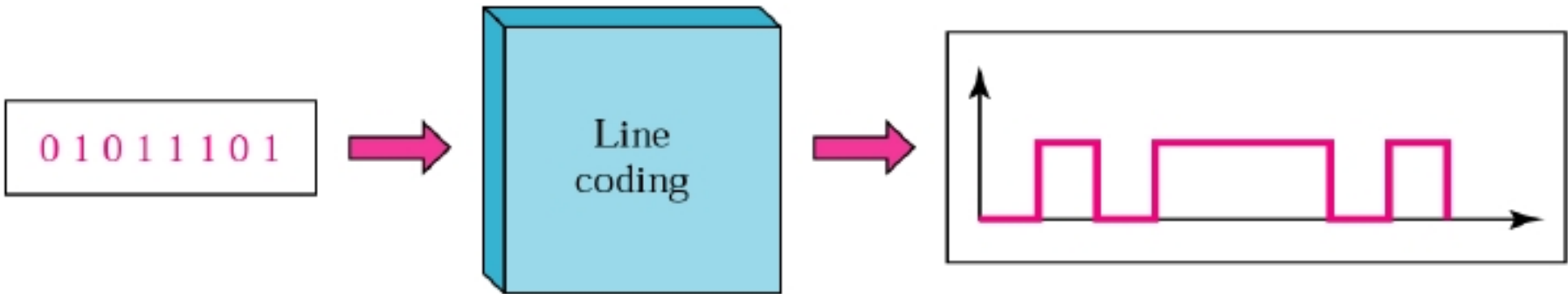
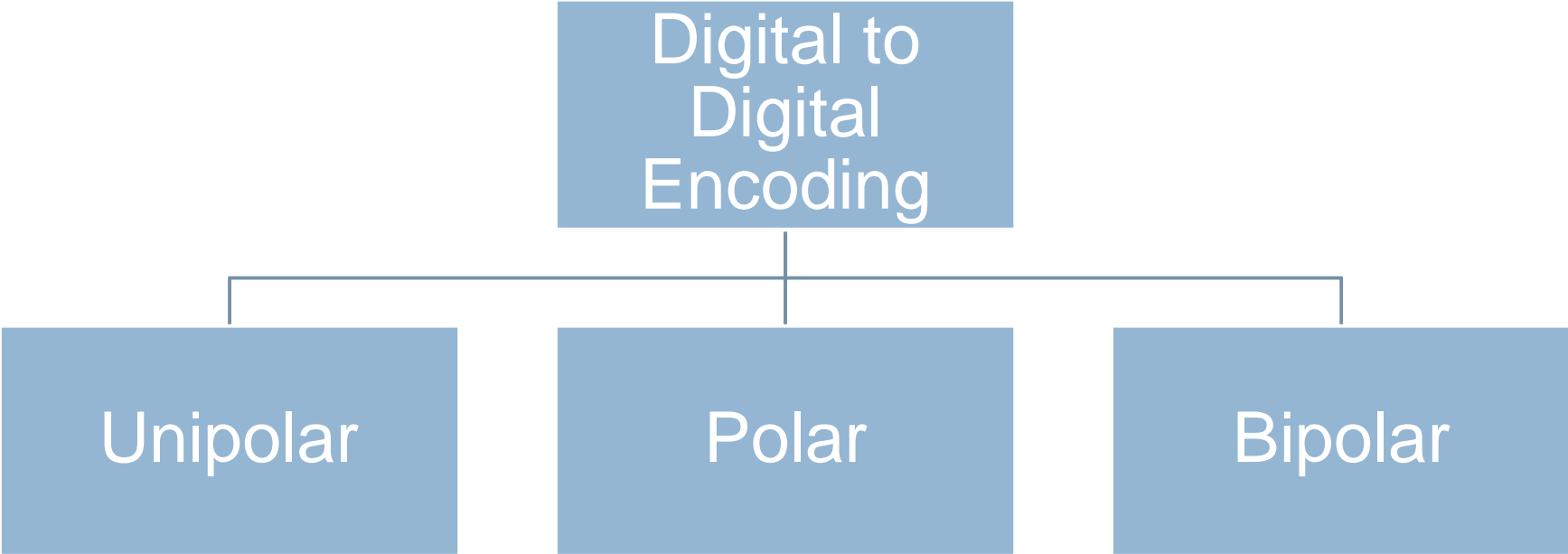

Characteristic of Line Coding



- Signal level versus data level
- Pulse rate versus bit rate
- dc components
- Self synchronization

Signal Level Versus Data Level

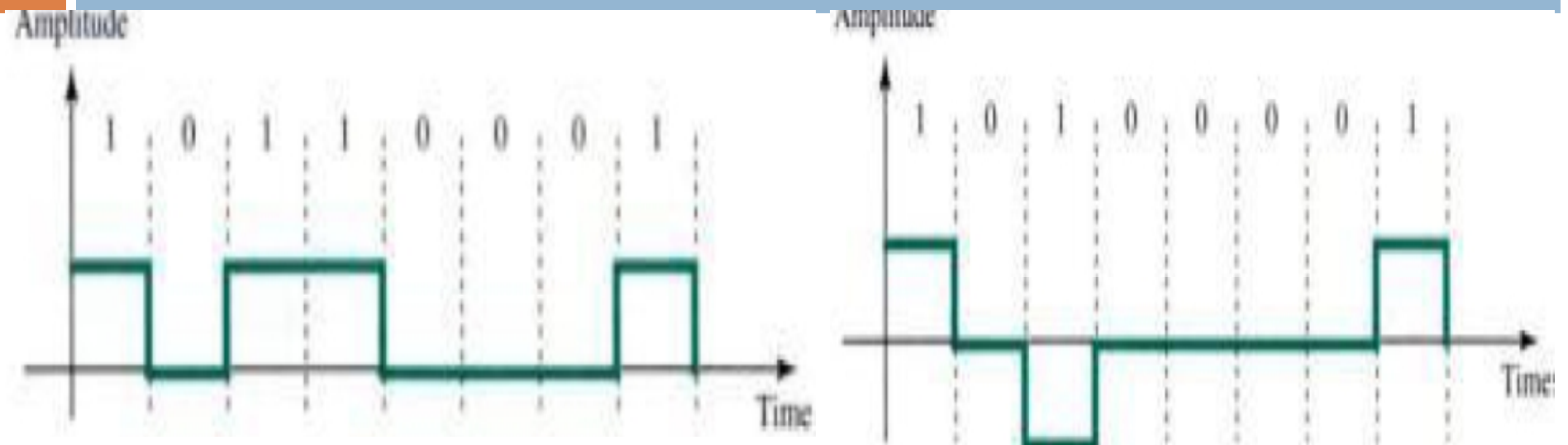

- First diagram has two signal levels and two data levels. The second diagram has three signal levels and two data levels.

DC Component

- First has a dc component, positive voltages are not cancelled by negative voltages.
- DC Signal Has Zero Frequency.

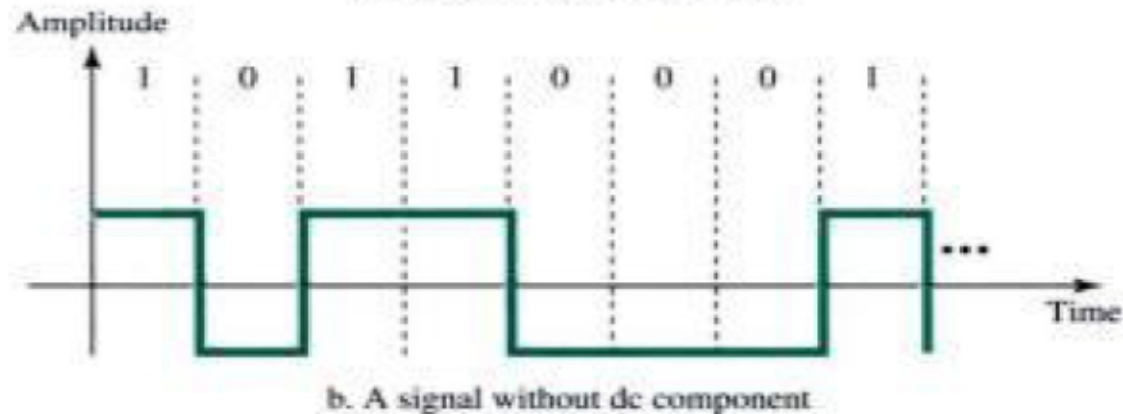
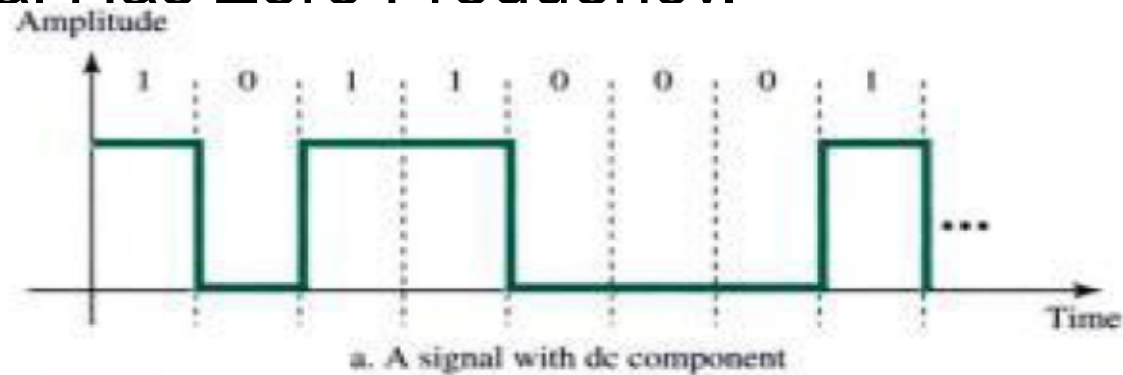

Lack of synchronization

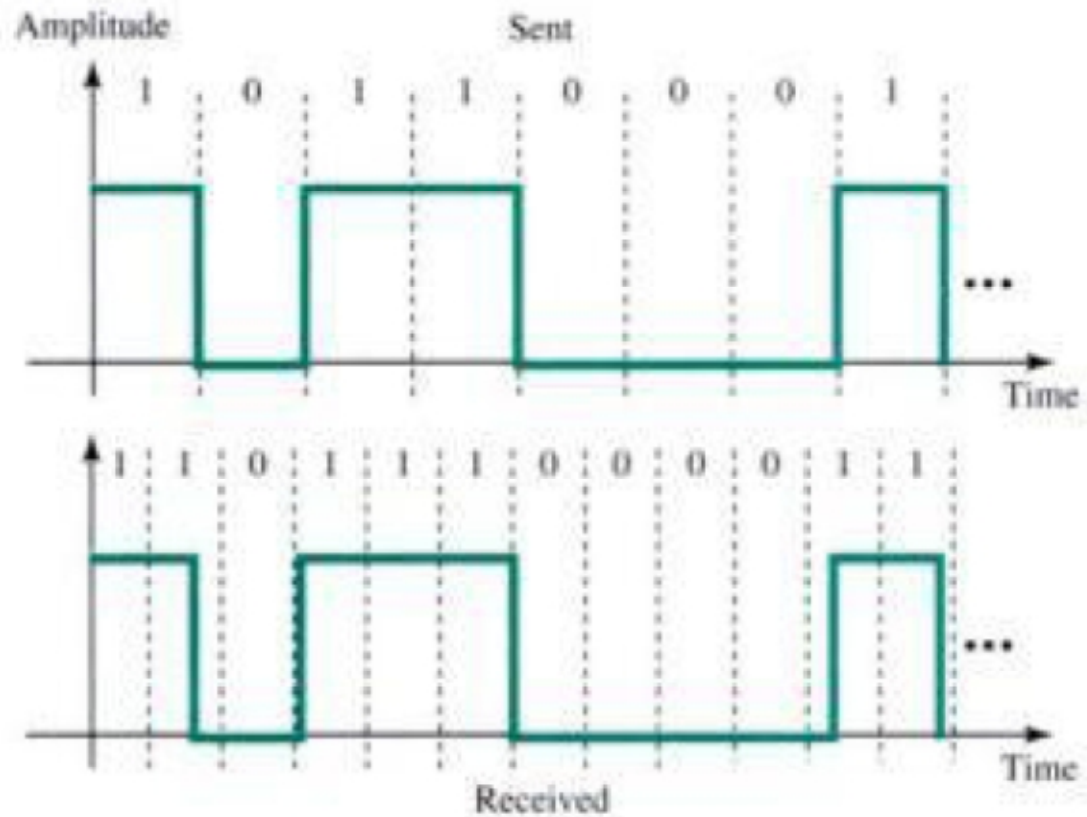

Self synchronization



- ❑ To correctly interpret the signals, receiver's bit intervals should exactly match with the sender's bit intervals.
- ❑ The ability to recover timing from the signal itself.
- ❑ Long series of ones and zeros could cause a problem.

Signalling rate versus bit rate

Signalling rate → number of signals per second. Signal is the minimum amount of time reqd to transmit a symbol.

Bit rate → number of bits per second. If a signal carries only 1 bit, the signalling rate and the bit rate are same.

$$\text{Bit rate} = \text{Signalling rate} * \log_2 L$$

L is the number of data levels in the signal.

Unipolar Encoding

- (also called on-off keying, OOK)
- Form of digital signal with only one level of amplitude.
- 1s are encoded as positive values. 0s are encoded as a zero value.

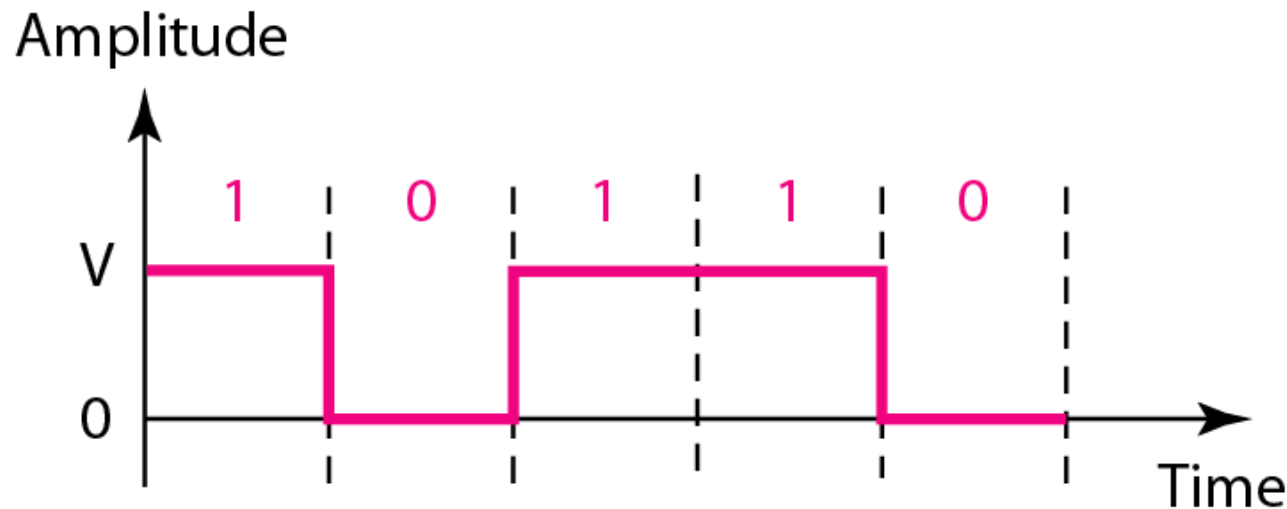

Limitations of unipolar encoding



- dc component
- Lack of synchronization

Average of unipolar encoded signal is non-zero,
so there is dc component.

Polar encoding



- It uses two voltage levels. positive and negative levels.
- Due to two voltage levels, there is a less problem of dc component.

Types of polar encoding

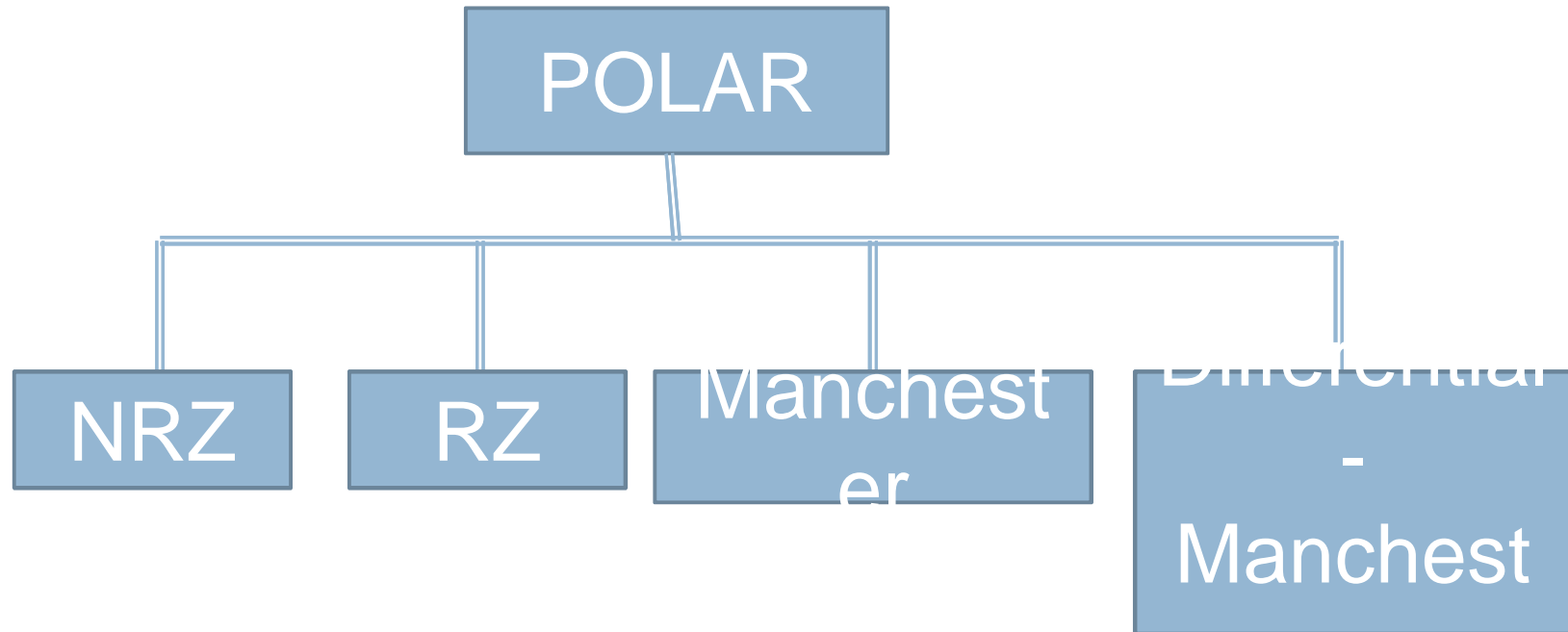

Non-return to Zero(NRZ)



- Value of the signal is either positive or negative.

Types of NRZ

→ NRZ-L

→ NRZ-I

NRZ-L encoding

- Level of signal depends upon the type of bit that it represents

1 \Leftrightarrow **-ve Voltage**

0 \Leftrightarrow **+ve voltage**

Limitation of NRZ-L

When data contains a long stream of 0s and 1s.

Receiver receives a continuous voltage and determines the number of bits by its clock which may or may not be synchronized with the sender clock.

NRZ-I encoding

- In NRZ-I, an inversion of the voltage level represents a 1 bit. It is the transition between a positive and a negative voltage.
- It is superior to NRZ-L due to the synchronization provided by the signal change each time a 1 bit is encountered.

1 \Leftrightarrow **Signal Change**

0 \Leftrightarrow **No Change**

NRZ-L and NRZ-I encoding

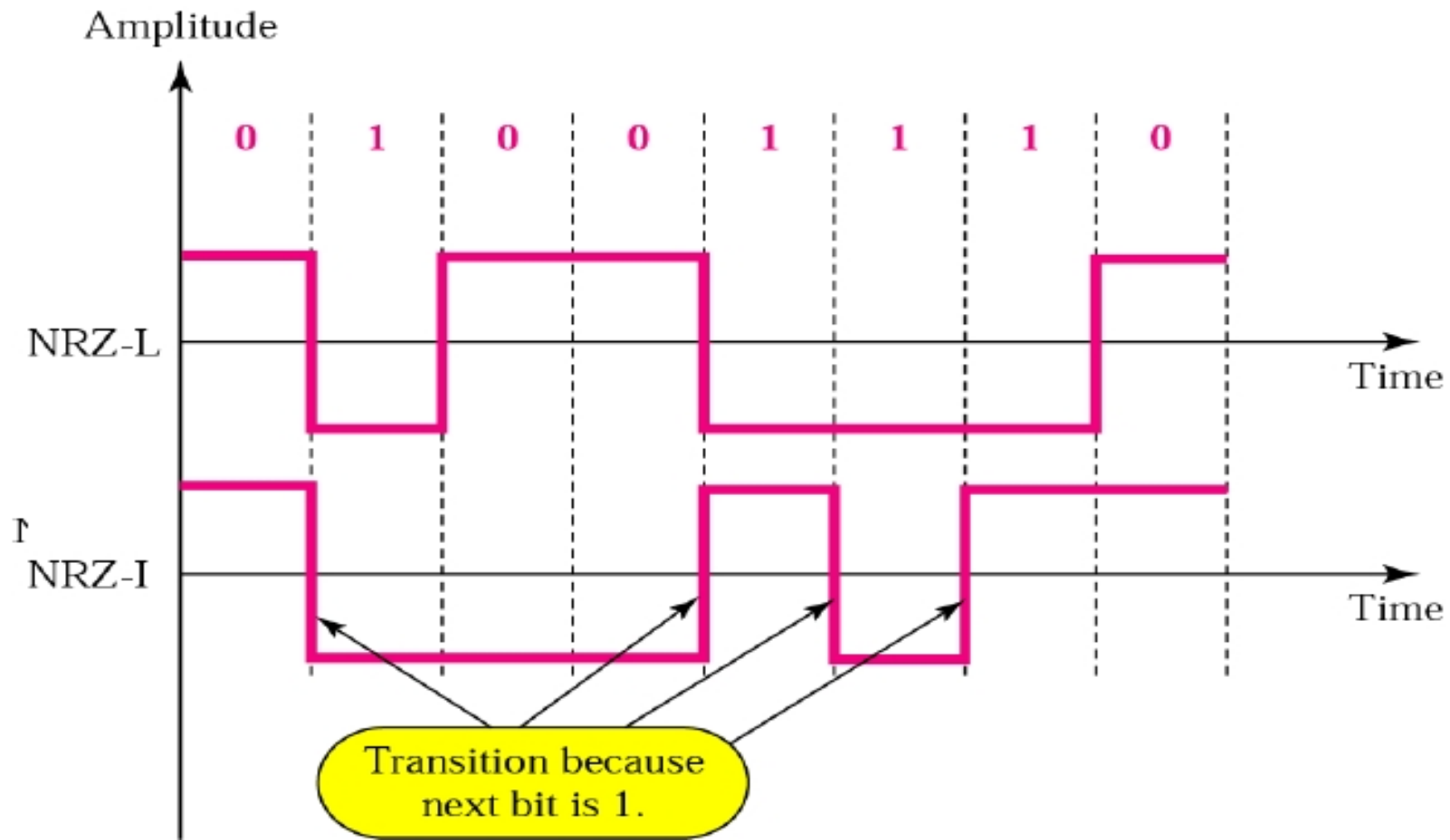
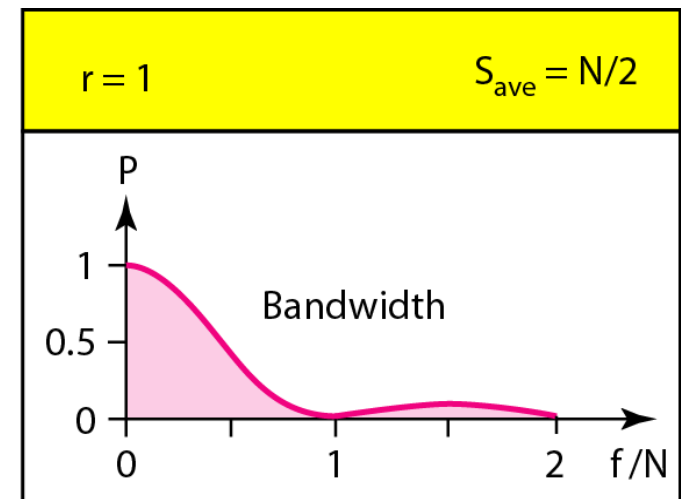
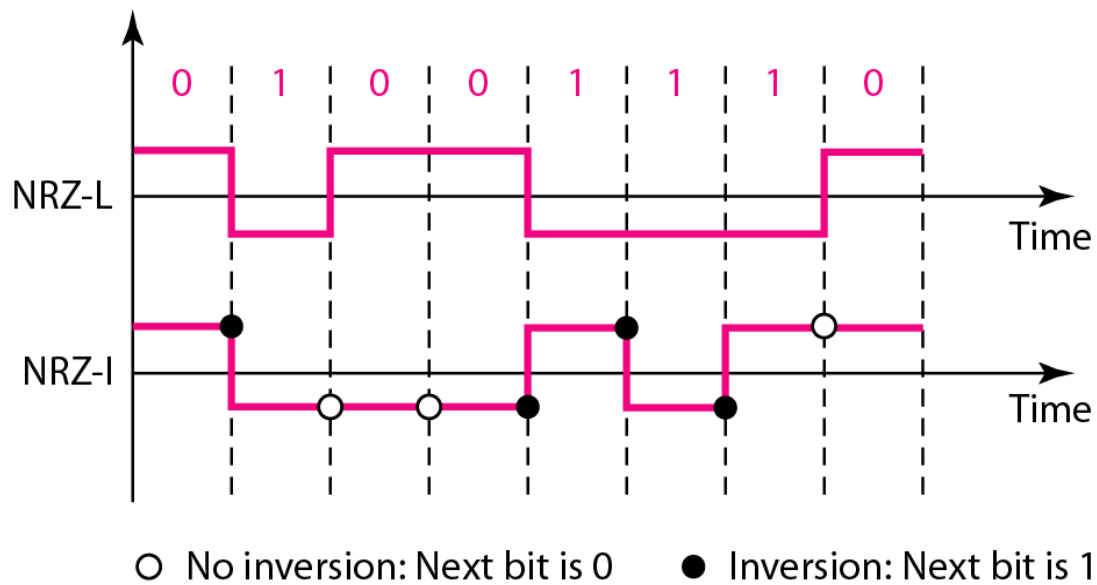

Figure 4.6 Polar NRZ-L and NRZ-I schemes



NRZ



- Advantages:

- Simplicity in implementation.
- No DC component.

- Disadvantages:

- Continuous part is non-zero at 0Hz. Causes “Signal Droop”.
- Does not have any error correction capability.
- Does not possess any clocking component for ease of synchronisation.
- Is not transparent.

RZ

- uses 3 values - +ve, -ve & zero.
- The signal is return to zero in midway of each duration.

1 \Leftrightarrow **+ve to Zero**
0 \Leftrightarrow **-ve to zero**

Amplitude

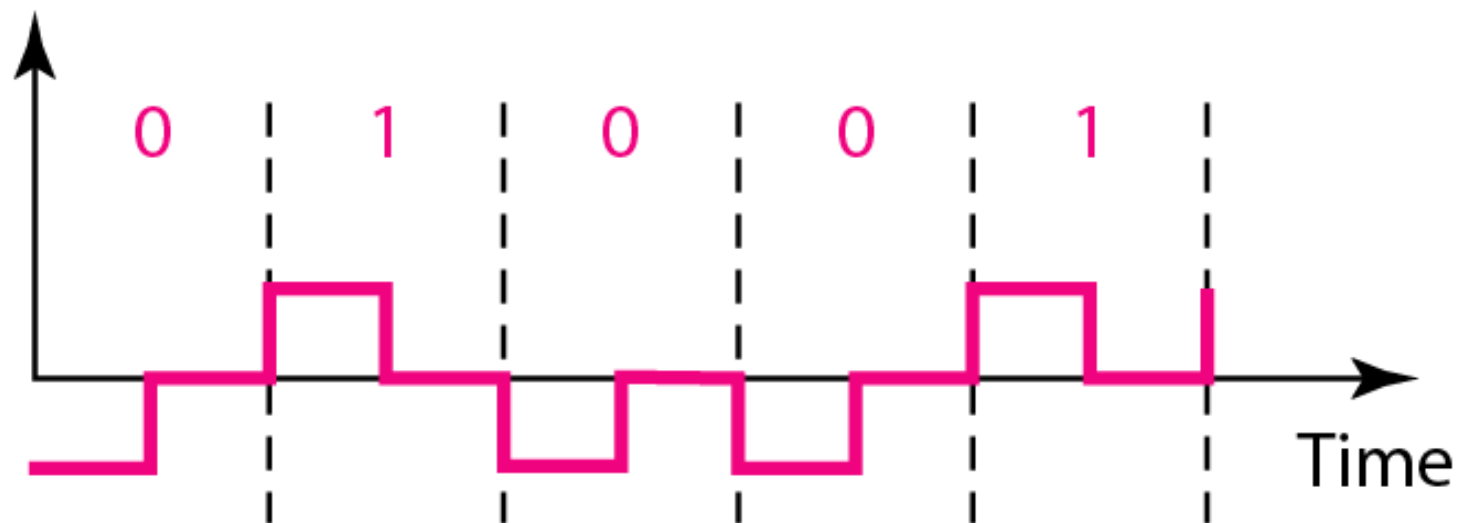

Manchester Encoding

- An inversion at the middle of each bit interval
- negative to positive transition represents binary 1, and a positive to negative transition represents binary 0.

Zero is  One is 

Amplitude

Zero is  One is 

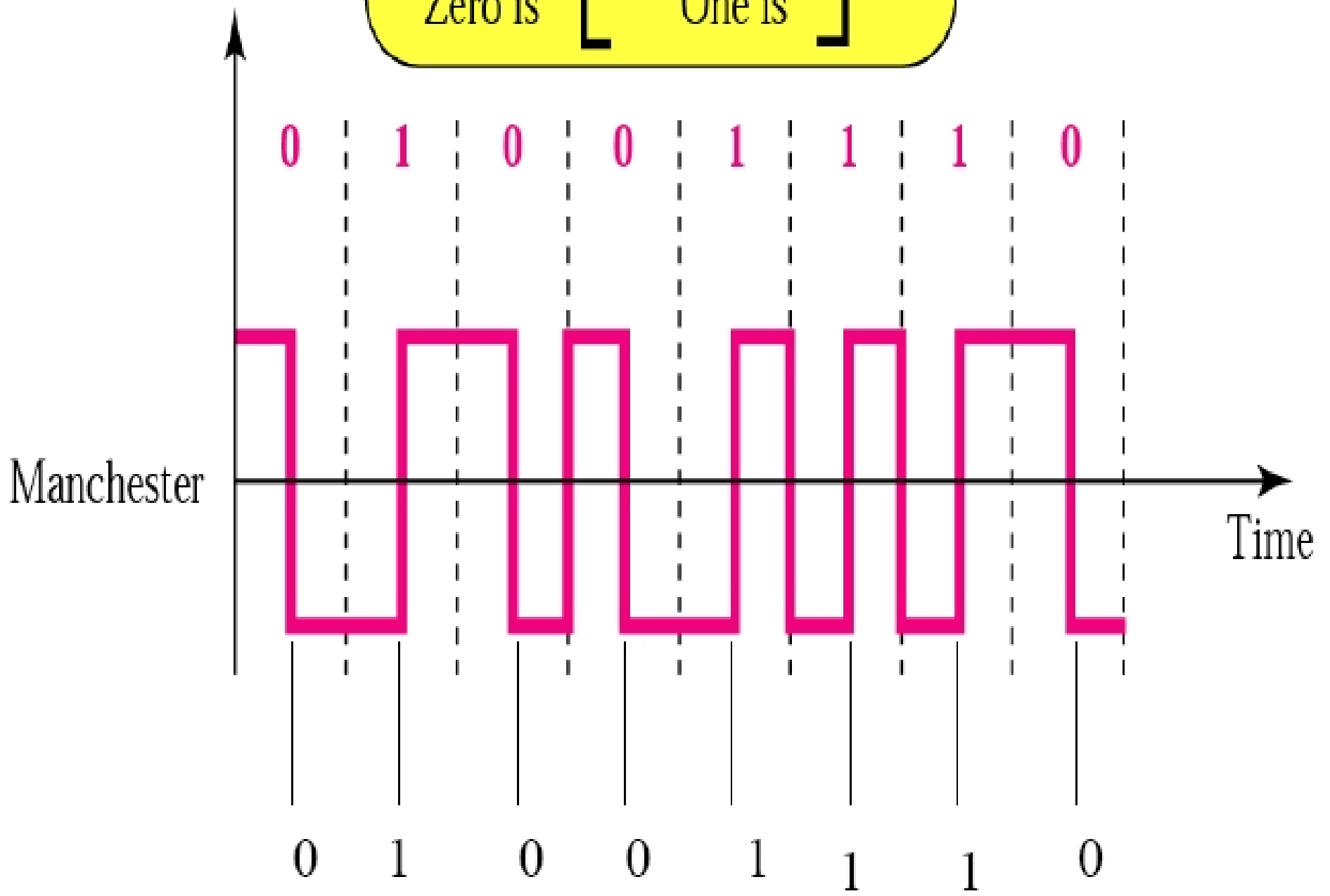

MANCHESTER

- Advantages:
 - No DC component.
 - Does not suffer from signal droop (suitable for transmission over AC coupled lines).
 - Easy to synchronise with.
 - Is Transparent.

- Disadvantages:
 - Because of the greater number of transitions it occupies a significantly large bandwidth.
 - Does not have error detection capability.

- These characteristic make this scheme unsuitable for use in Wide Area Networks. However, it is widely used in Local Area Network such as Ethernet and TokenRing.

Differential Manchester

- inversion at the middle of the bit interval is used for synchronization, but the presence or absence of an additional transition at the beginning of the interval is used to identify the bit.
- A transition means binary 0 and no transition means binary 1

1 ⇔ **absence** of transition at the beginning of the bit interval
0 ⇔ **presence** of transition at the beginning of the bit interval

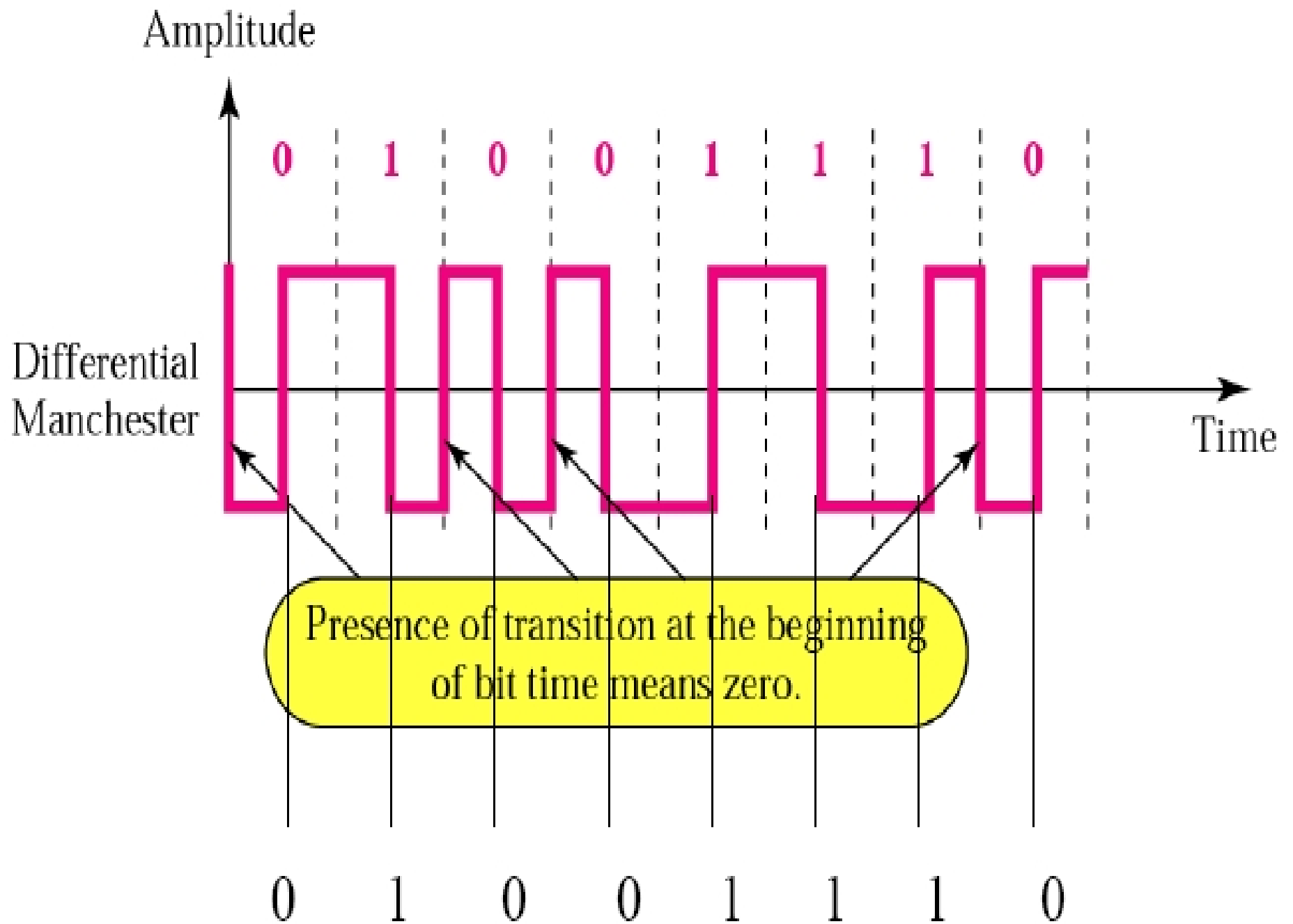

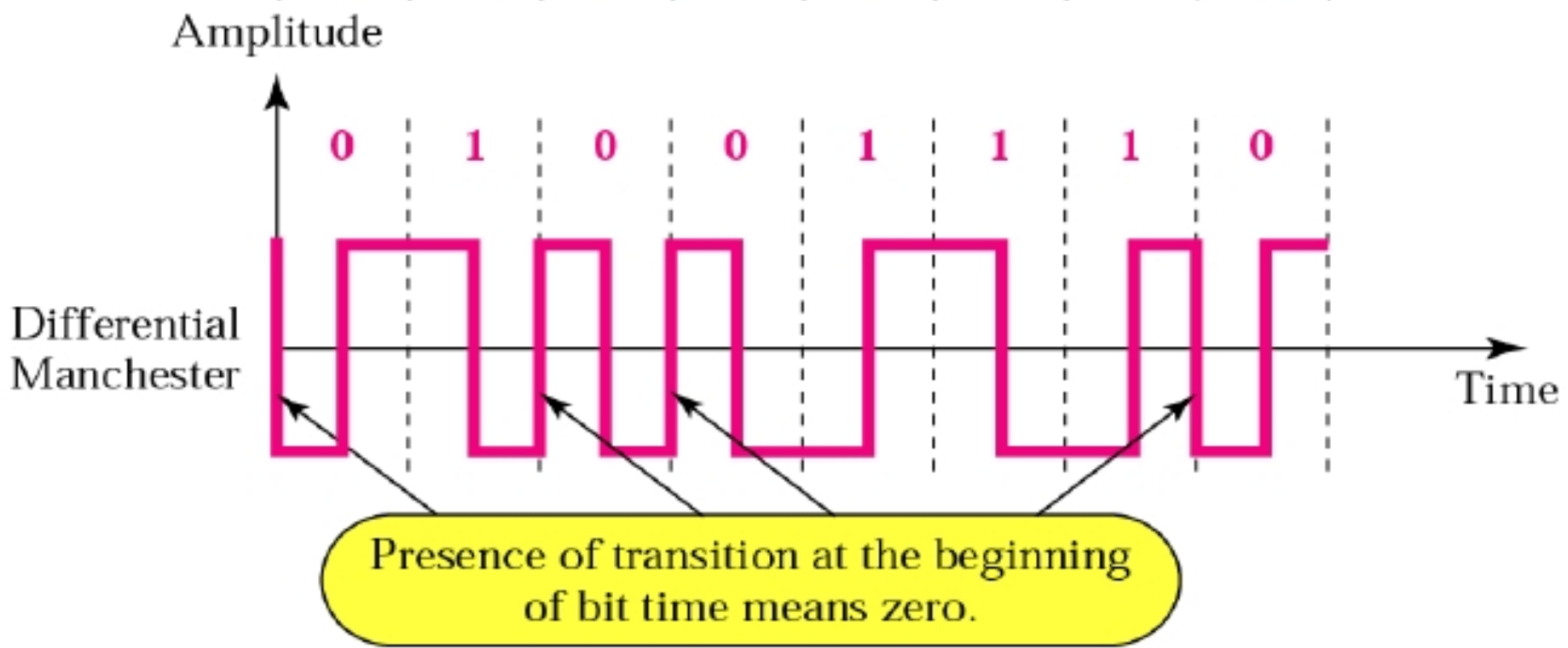
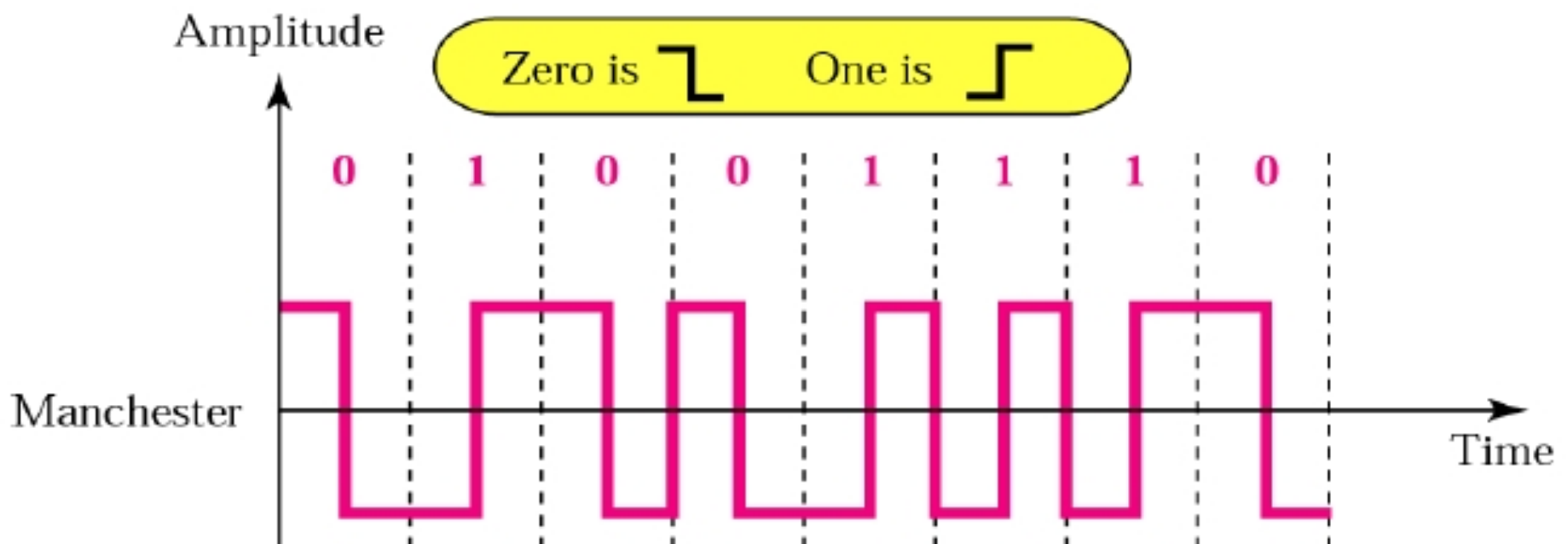

Bipolar

- 3 voltage level-- +ve , '0' & -ve.
- Alternate Mark Inversion (AMI)
- Pseudoternary

1 \Leftrightarrow **alternating** +1/2 , -1/2 voltage

0 \Leftrightarrow **0** voltage

Bipolar-AMI

0 = no line signal

1 = positive or negative level, alternating for successive ones

Pseudoternary

0 = positive or negative level, alternating for successive zeros

1 = no line signal

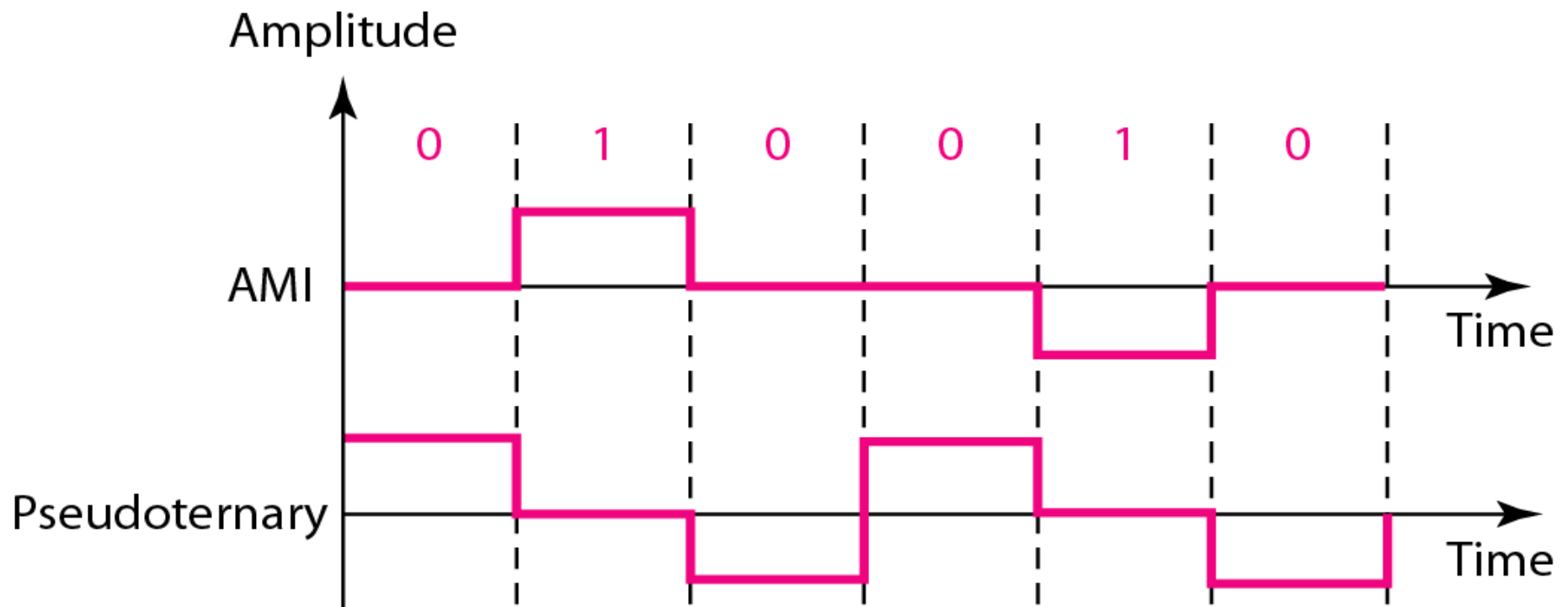

High Density Bipolar-3 zeros (HDB3)

Bipolar with 8-Zero Substitution (B8ZS)

Comparison of Line Codes

- Self-synchronization:
 - ▣ Manchester codes have built in timing information because they always have a zero crossing in the center of the pulse.
 - ▣ Polar RZ codes tend to be good because the signal level always goes to zero for the second half of the pulse.
 - ▣ NRZ signals are not good for self-synchronization.
- Error probability:
 - ▣ Polar codes perform better (are more energy efficient) than Unipolar or Bipolar codes.
 - ▣ Channel characteristics:
- Depends upon the PSD of the line codes.

Digital to Analog encoding

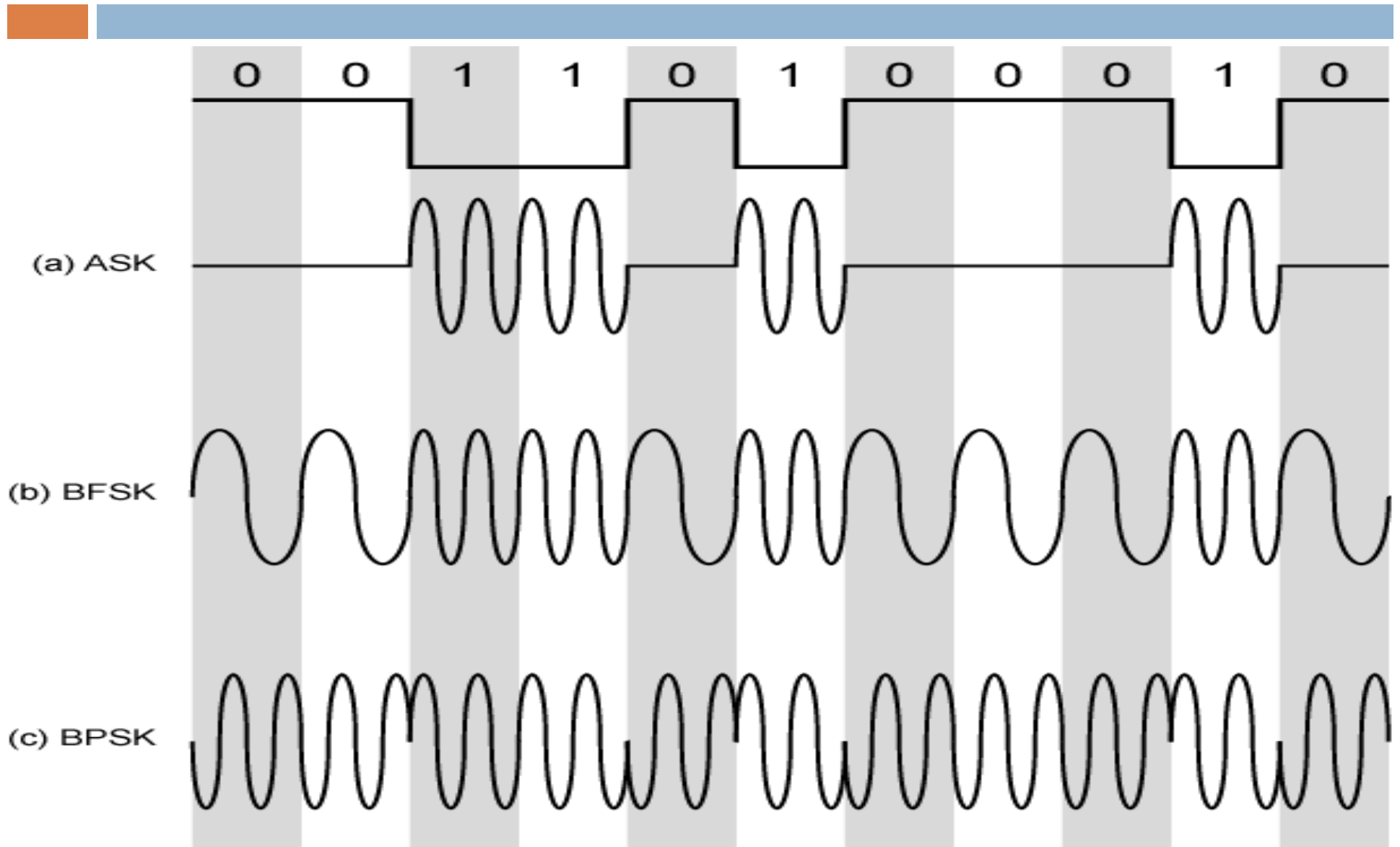

Analog to analog encoding



- AM
- FM
- PM

Analog to digital encoding

Message
signal
(analog)

